

BAYKAL

WELDING SOLUTION

BAYKAL

SPECIFICATIONS



🔧 Tower Foot Welding Solution Specs

Robot	BR20iA-20
Welding Equipment	Artsen Pro 500P Power Source, Built-in Water Cooled Wire Feeder Welding Torch, Anti-collision Device, Torch Cleaning Station
Parametric Programming Software	Tower Foot Intelligent Welding System
Welding Torch Neck Angle	22°/36°/45°/180°(welding torch neck can be replaced)
Welding Power Supply	Large penetration pulse process, no root cleaning
Welding Torch Temporary Load Rate	100%
Laser Weld Tracking Sensor	Line Laser
Laser Power	10~40W (adjustable)
Base	Modular Standard Base
Touch Screen	15 inch
Torch Cleaning Station	Unique fuel injection bin design, to ensure that anti-splash liquid spray evenly

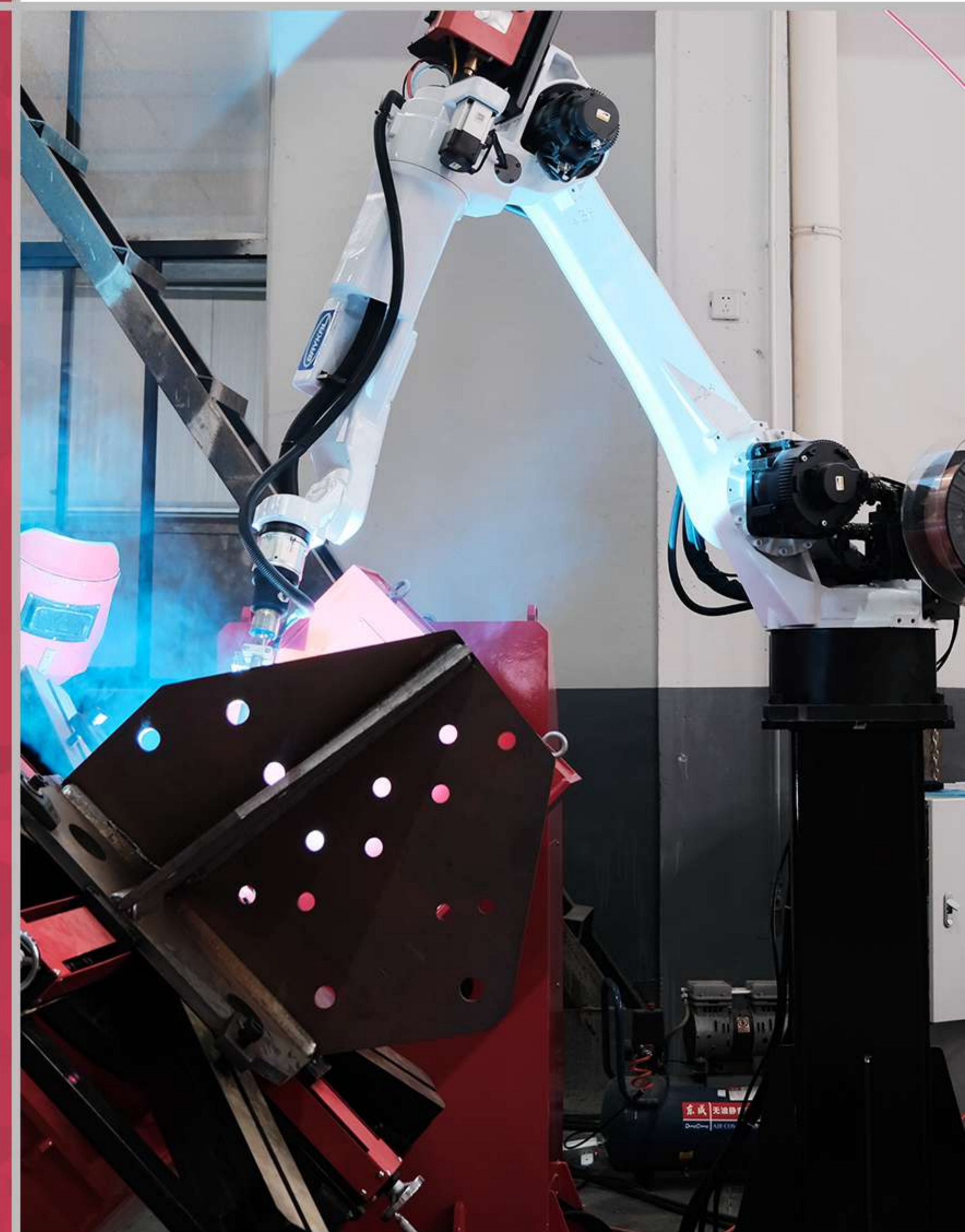

Tower Foot Welding 3-Minutes Intelligent Solution

ROBOTIC WELDER

More Efficient More Reliable Robotic Systems

www.baykalrobot.com

Factory Add: No. 386, Renmin West Road,
Hudai Town, Binhu District, Wuxi City,
Jiangsu Province

www.baykalrobot.com

Email: info@baykalrobot.com

AUTOMATED WELDING OF ATTACHMENTS

BAYKAL IS COMING!

- ✓ Compact
- ✓ Efficient
- ✓ Affordable

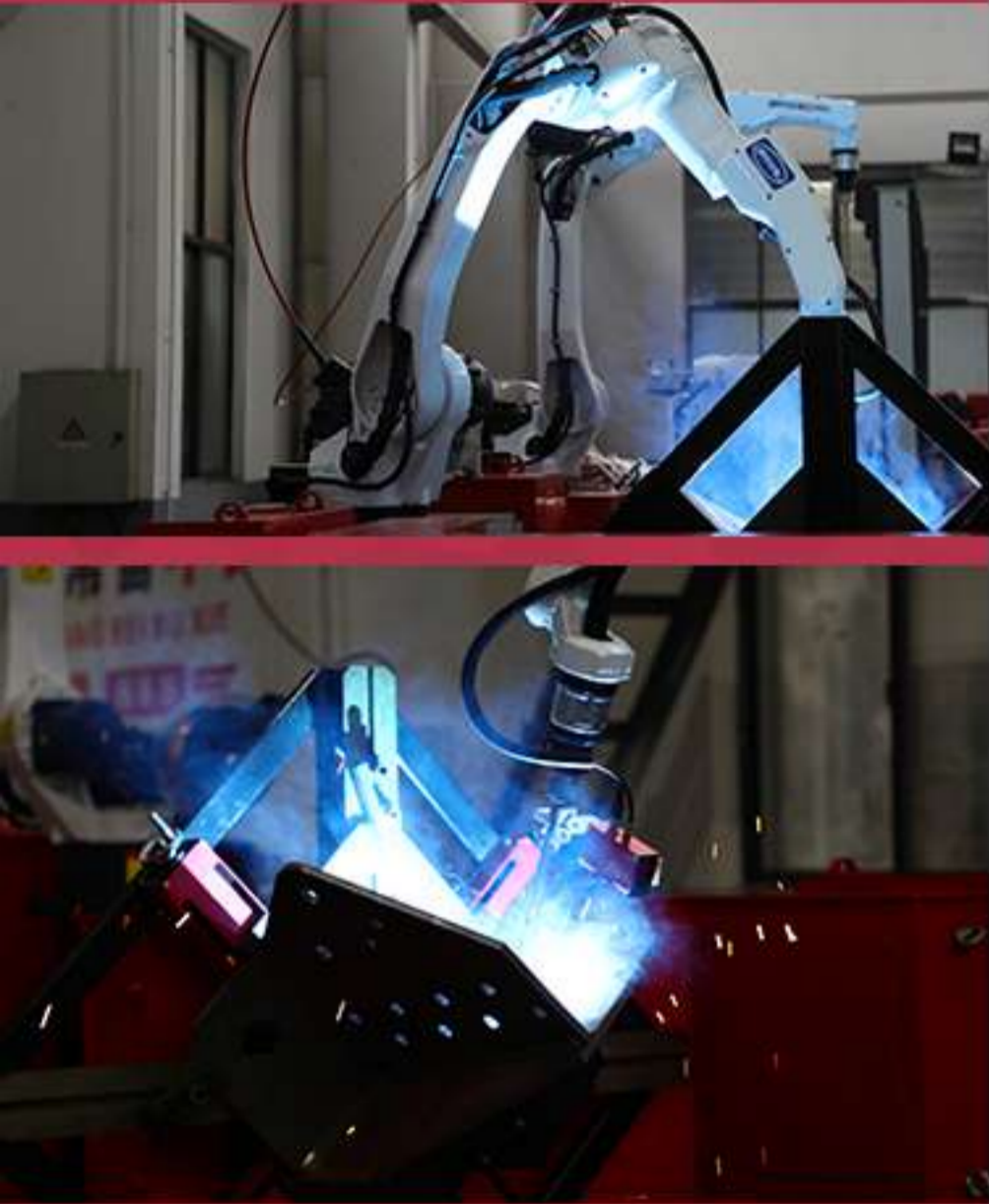

FULLY AUTOMATED

The tower foot intelligent solution is highly integrated, plug and play, new products only take 3 minutes to start welding, no need to switch procedures, and welding procedures are automatically generated

- Highly Integrated
- Affordable
- Efficient
- Robust
- Accurate
- Plug and Play
- Easy to Operate
- Less than the cost of 3 welders

HIGH PRECISION POSITIONER

2 axis positioner, can load 2 tons

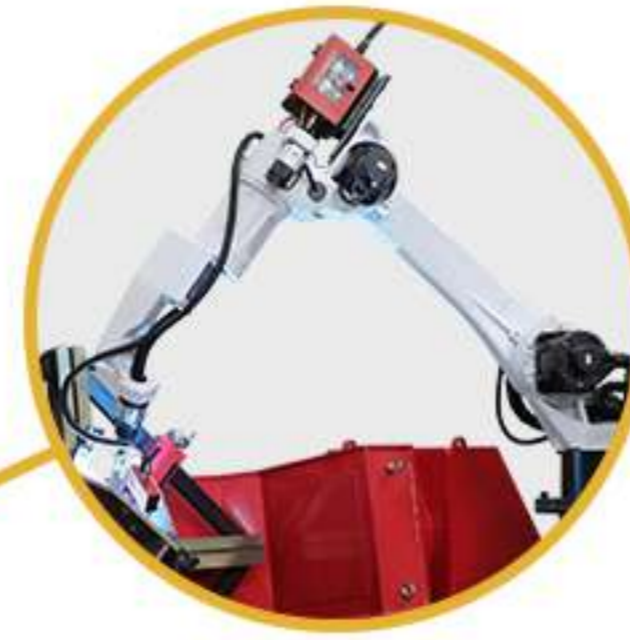
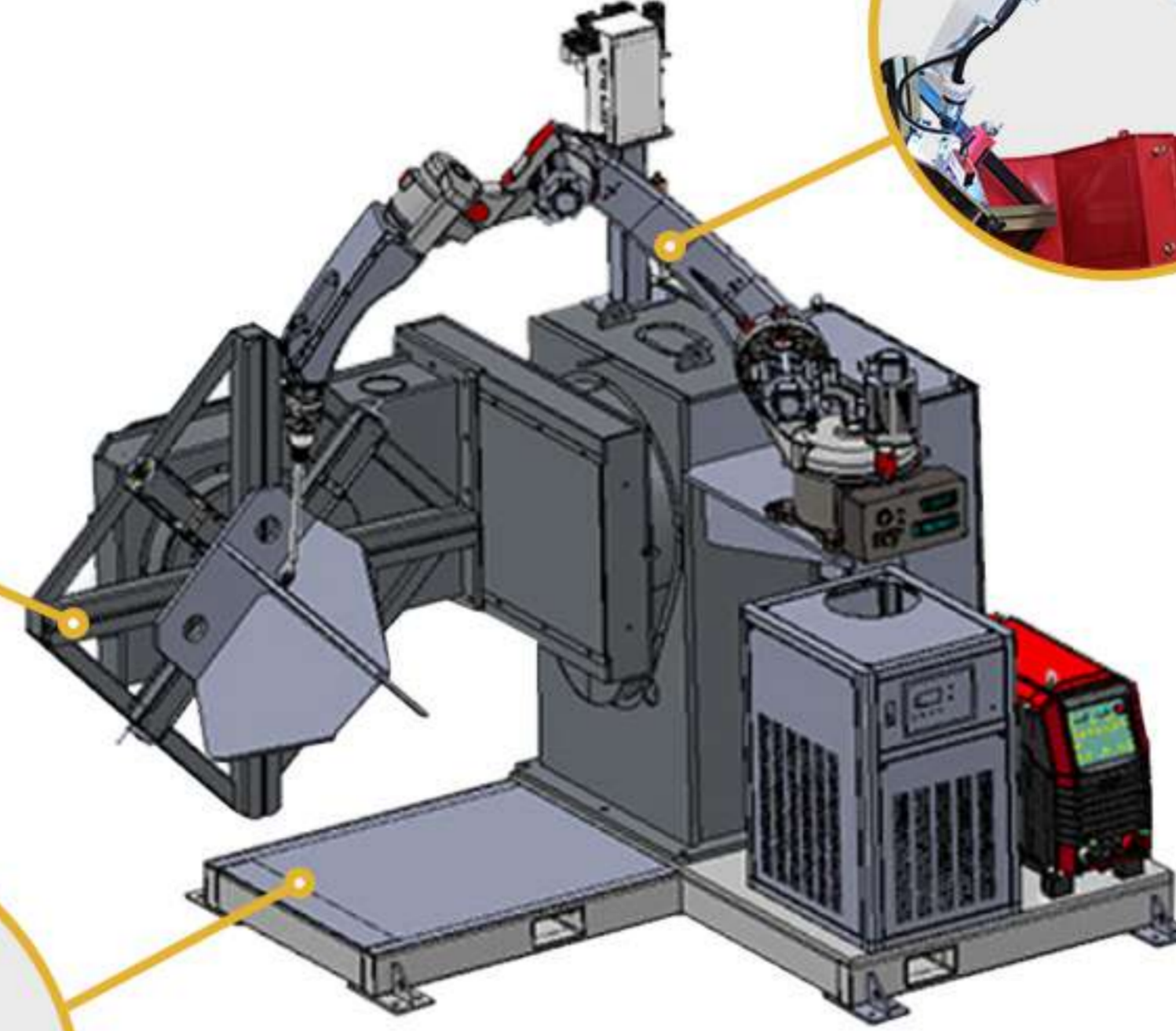
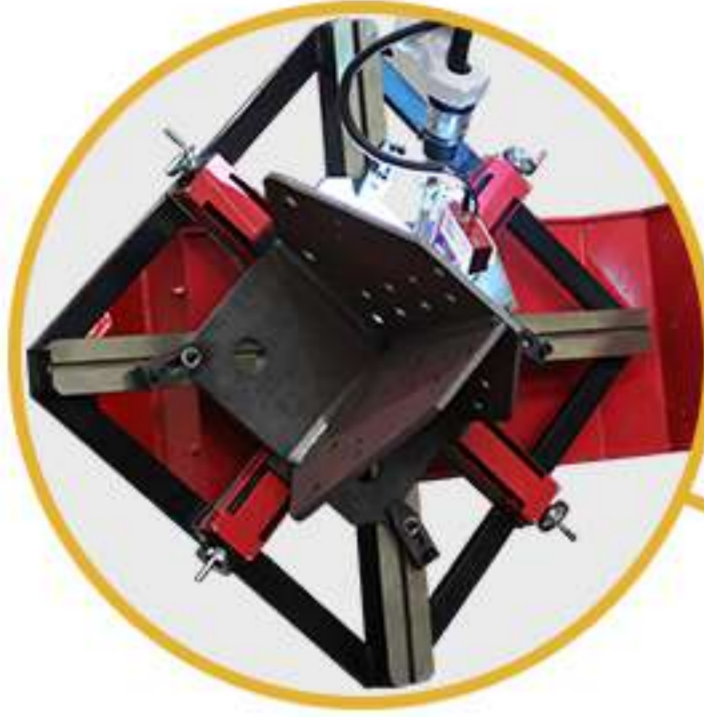

ROBUST WELDING ROBOT

Robots are designed to work in the harshest conditions for years with minimal maintenance.



CONTROL PANEL

An easy-to-use touchscreen is integrated all the database for the powerful welding, and it is very easy to operate. It doesn't matter what size work piece you are going to weld, you can directly touch and set up the value.

HIGHLY INTEGRATED AND INSTALLATION-FREE

As a majored welding solution, and our mechanism is ready to go structure. For the positioner and the robot position we have specified the distance.



■ ROBUST WELDING ROBOT

THE SOLUTION TO YOUR PROBLEM

With the number of skilled welders available in the workforce dwindling, and the cost of recruiting & retaining them rising, Now is the time to consider automating the welding process.

Tower foot welding often faces the demand of small batch and variety, want to realize automation, but the normal robot welding programming is complex, low efficiency. If we can solve the problem of time consuming programming, efficiency will be greatly improved.

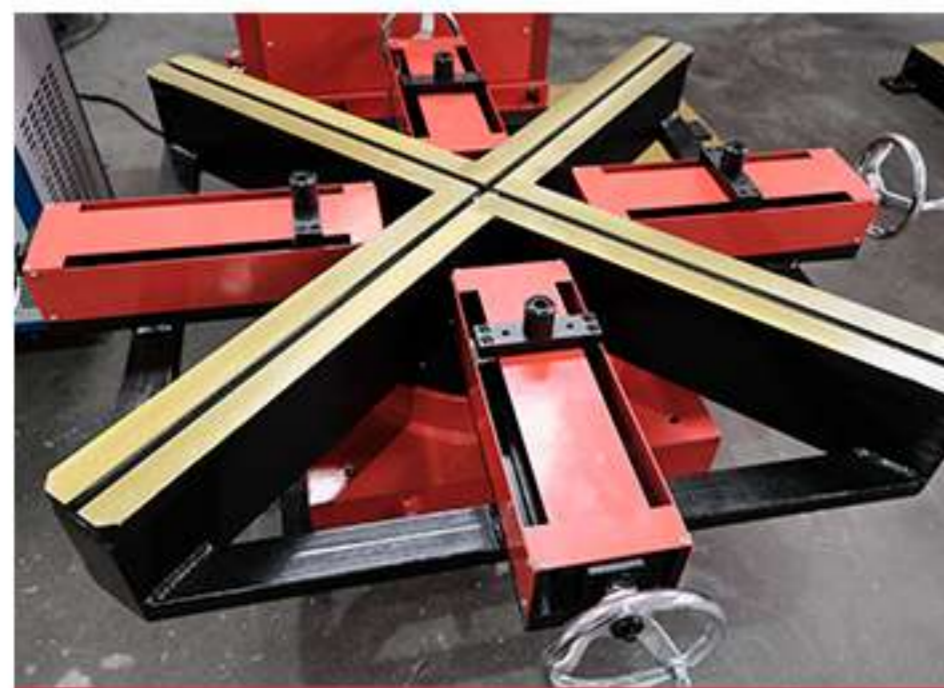

■ HIGH PRECISION POSITIONER

A NEW WAY TO INCREASE PROFITS

Tower Foot Welding - 3 minute intelligent solution is designed for tower foot manufacturers. The compact footprint, robotic automation and automatic generation of welding procedures make it an ideal solution for tower foot manufacturers striving to improve efficiency and reduce labor costs.



■ INDEPENDENT CONSOLE



■ BAYKAL ARC WELD ROBOT BR201A-20

OPERATION

1. After the parts are spot-welded and assembled manually, placed them on the fixture platform.
2. Determine the size of tower foot and welding process parameters.
3. The robot starts to automatically generate weld procedures according to product parameters.
4. The robot performs multi-layer and multi-pass welding according to the welding procedure.

Standard parameter database, one key import and export. No need to program, one key start, one key to zero, simple operation, easy to use. We want to make everyone can operate this robot easily.

HIGHLY INTEGRATED AND FAST LAYOUT

Tower foot welding solution is highly integrated, We will finish all installation before sending the solution to you. More important, we have the positions for the fork lifter, by this way, you can carry it to anywhere for your work.



■ LASER TOUCH SENSING OF PART TO BE WELDED

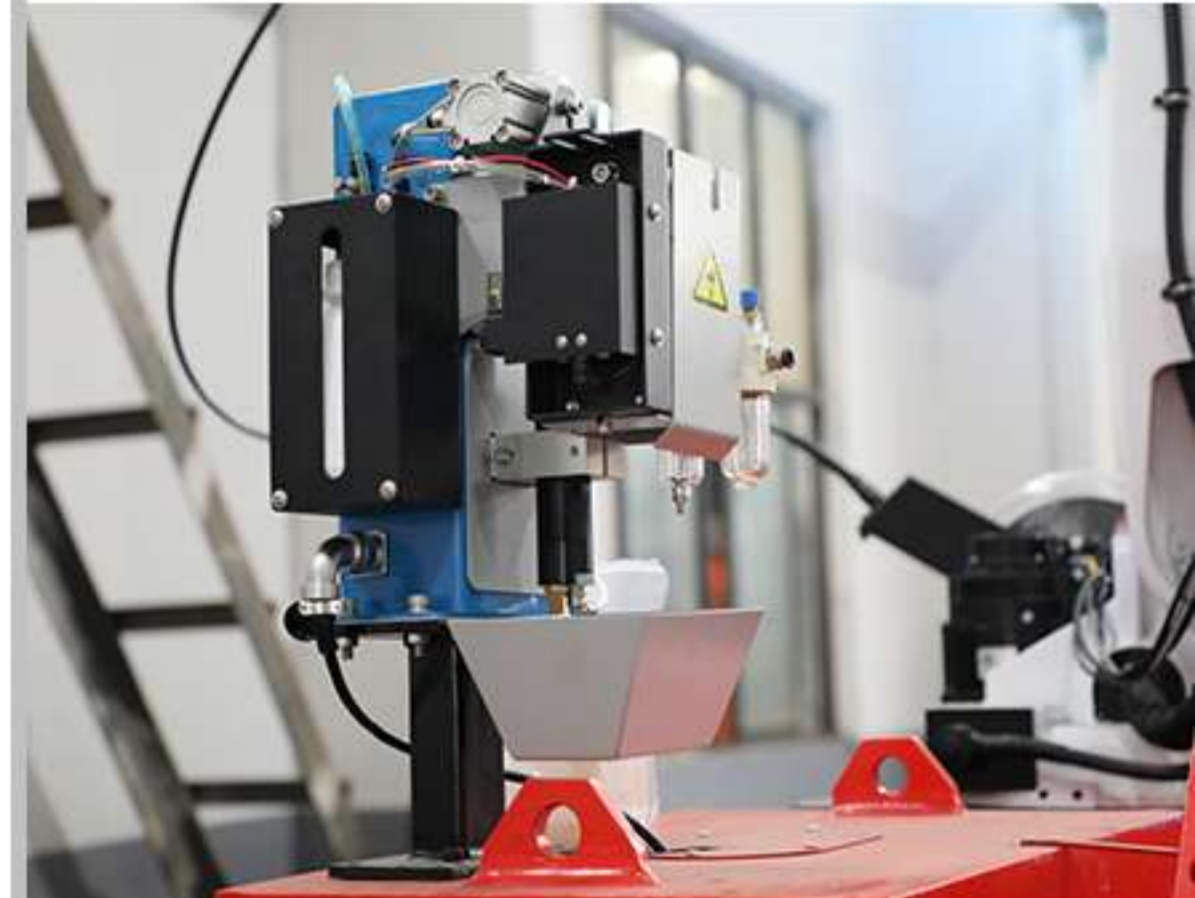

■ TORCH CLEANING STATION



■ EASY-TO-USE GRAPHIC INTERFACE

UNBEATABLE TECH SUPPORT

- BAYKAL provide you with the support of professional service technicians, multilingual professional engineers perform online machine diagnostics in 24 hours. They have the ability to provide you with direct troubleshooting via the Internet or phone, as well as on-site repair of the machine if necessary.